

# 3SK88 Datasheet



## MOS FIELD EFFECT TRANSISTOR 3SK88

### RF AMP. FOR UHF TV TUNER N-CHANNEL SILICON DUAL-GATE MOS FIELD-EFFECT TRANSISTOR DISK MOLD

PACKAGE DIMENSIONS (Unit : mm)

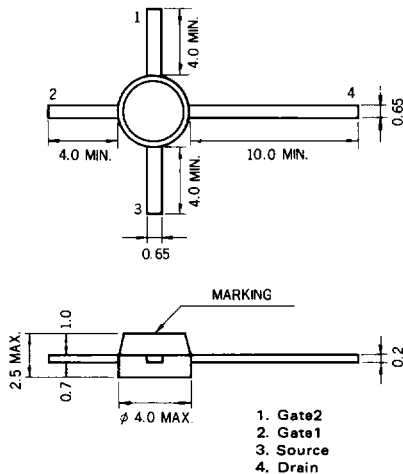

#### FEATURES

- Suitable for use as RF amplifier in UHF TV tuner.
- Low  $C_{rss}$  : 0.02 pF TYP.
- High  $G_{ps}$  : 16 dB TYP.
- Low NF : 3.8 dB TYP.

#### ABSOLUTE MAXIMUM RATINGS (Ta = 25 °C)

Drain to Source Voltage	$V_{DSX}$	20	V
Gate1 to Source Voltage	$V_{G1S}$	±10	V
Gate2 to Source Voltage	$V_{G2S}$	±10	V
Drain Current	$I_D$	25	mA
Total Power Dissipation	$P_T$	200	mW
Channel Temperature	$T_{ch}$	125	°C
Storage Temperature	$T_{stg}$	-65 to +125	°C

#### ELECTRICAL CHARACTERISTICS (Ta = 25 °C)

CHARACTERISTIC	SYMBOL	MIN.	TYP.	MAX.	UNIT	TEST CONDITIONS
Drain to Source Breakdown Voltage	$BV_{DSX}$	20			V	$V_{G1S} = V_{G2S} = -2 V, I_D = 10 \mu A$
Drain Current	$I_{DSS}$	0.01		6	mA	$V_{DS} = 10 V, V_{G2S} = 4 V, V_{G1S} = 0$
Gate1 to Source Cutoff Voltage	$V_{G1S(off)}$			-2.0	V	$V_{DS} = 10 V, V_{G2S} = 4 V, I_D = 10 \mu A$
Gate2 to Source Cutoff Voltage	$V_{G2S(off)}$			-0.7	V	$V_{DS} = 10 V, V_{G1S} = 4 V, I_D = 10 \mu A$
Gate1 Reverse Current	$I_{G1SS}$			20	nA	$V_{DS} = 0, V_{G1S} = \pm 10 V, V_{G2S} = 0$
Gate2 Reverse Current	$I_{G2SS}$			20	nA	$V_{DS} = 0, V_{G2S} = \pm 10 V, V_{G1S} = 0$
Forward Transfer Admittance	$ Y_{fs} $	14	17		mS	$V_{DS} = 10 V, V_{G2S} = 4 V, I_D = 10 mA, f = 1 kHz$
Input Capacitance	$C_{iss}$	1.5	2.0	2.5	pF	$V_{DS} = 10 V, V_{G2S} = 4 V, I_D = 10 mA, f = 1 MHz$
Output Capacitance	$C_{oss}$	0.5	1.0	1.5	pF	
Reverse Transfer Capacitance	$C_{rss}$		0.02	0.03	pF	
Power Gain	$G_{ps}^*$	14	16	18	dB	$V_{DS} = 10 V, V_{G2S} = 4 V, I_D = 10 mA, f = 900 MHz$
Noise Figure	NF*		3.8	5.5	dB	

$I_{DSS}$  Classification L: 0.01 - 2 mA K: 1 - 6 mA  
\*See Test Circuit

TYPICAL CHARACTERISTICS (Ta = 25 °C)

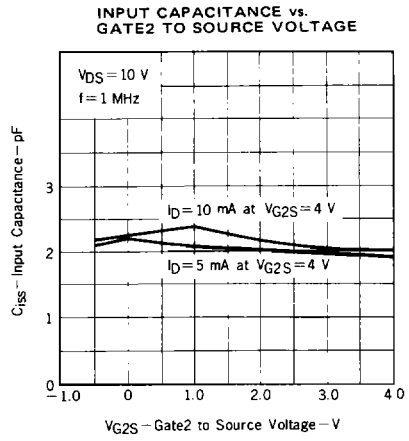
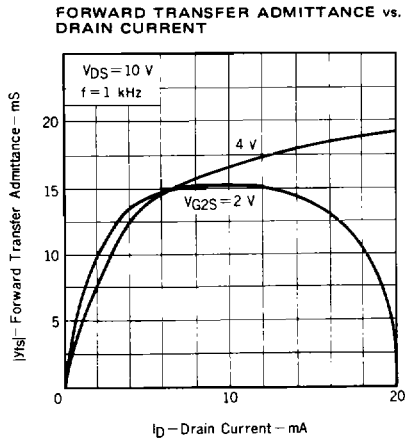
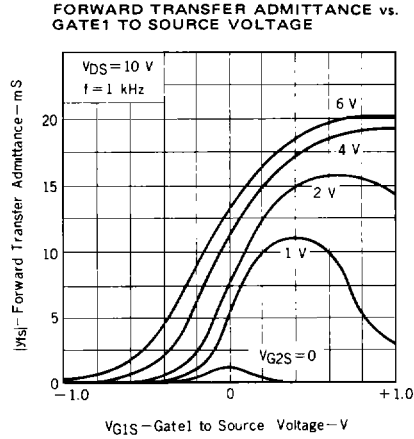
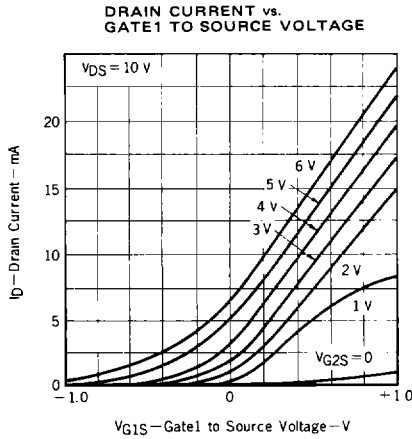
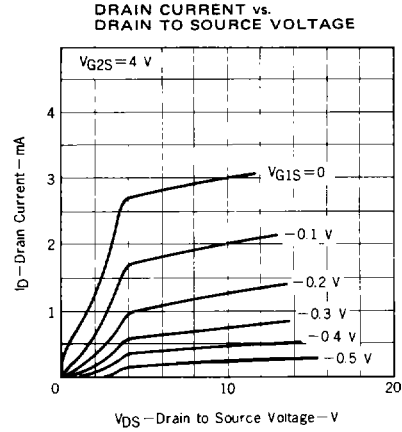
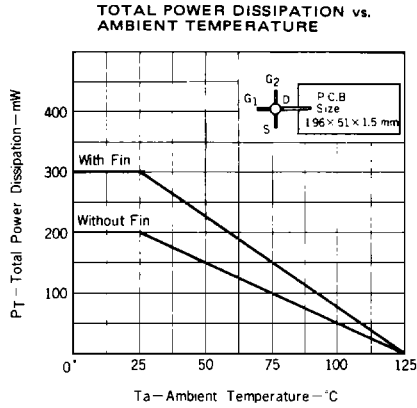

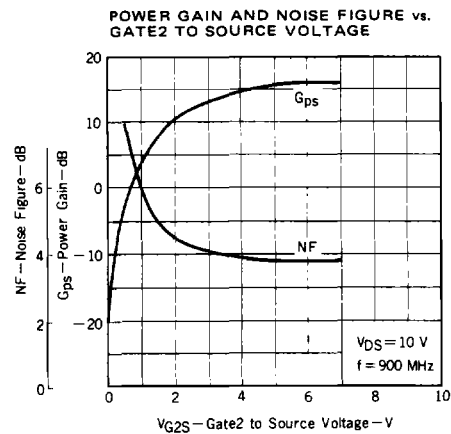
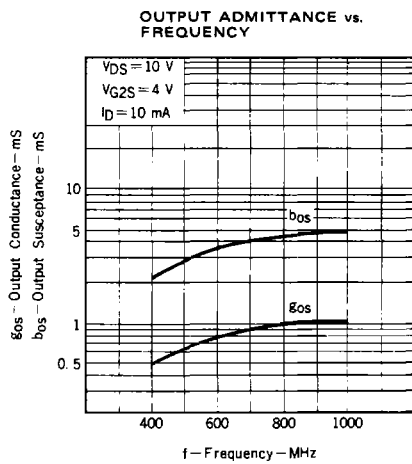
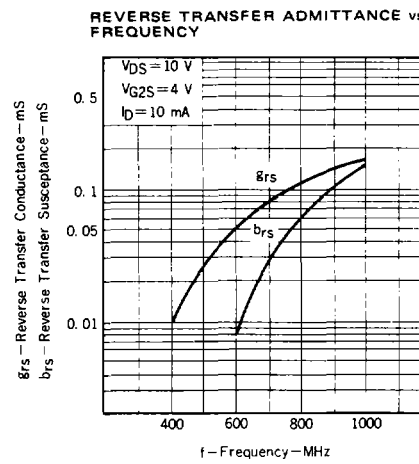
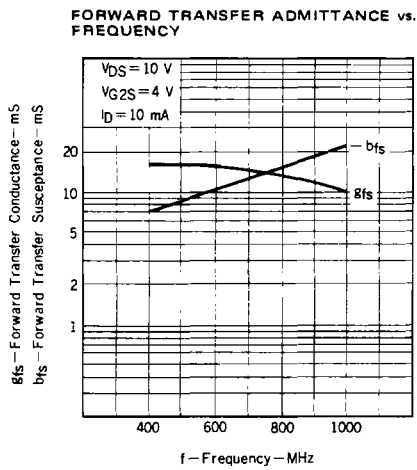
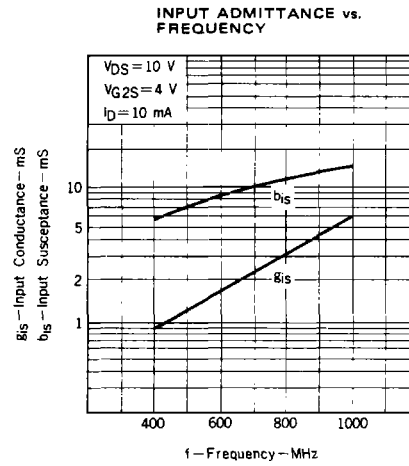
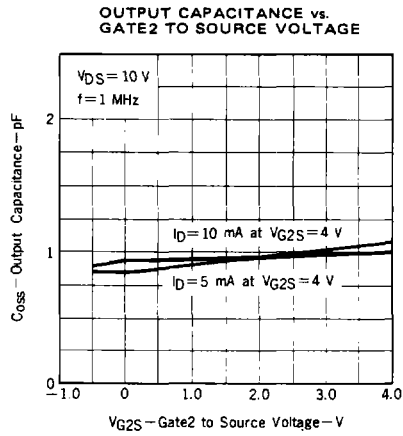

900 MHz  $G_{ps}$  AND NF TEST CIRCUIT

